

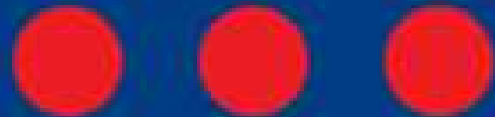

TECHNICAL  
SERVICES  
CATALOGUE

● ● ● 2027



---

## TECHNICAL SERVICES CATALOGUE \_VER\_2027\_DEFEA\_V1

Introduction

02

Standard shell  
scheme stands

06

# SERVICE CATALOGUE INDEX

Electrical  
equipment

08

Stand equipment:  
Partitions/  
Panels/Doors

10

Stand equipment:  
Ceilings

10

Stand  
equipment:  
Chairs &  
Armchairs

12

Stand  
equipment:  
Stools & Sofas

16

Stand equipment:  
Tables

18

Stand equipment:  
Desks &  
Drawers/  
Showcases

20

Stand equipment:  
Special  
equipment

22

Stand equipment:  
Floors &  
Coatings

24

Signage /  
Printing services

26

Aluminum  
framed printings  
for rigging

30

Light box  
with led  
lighting

30

Audiovisual  
- Office  
equipment

32

Cleaning  
services

34

Security  
services

36

Photo  
- Video

36

Internet

38

Connections to  
water supply  
& drainage  
network

40

Connections  
to ventilation  
network

40

Rigging services

42

Extra  
rigging  
equipment

44

Notes

46

Stand  
drawing  
form

47

Information

48

Instructions

49

# Expowork Bench mark in modern exhibitions

EXPOWORK was founded in August 2003, as the official technical contractor of the most modern exhibition center in Greece at that time, EXPOATHENS. Following this successful business model, EXPOWORK offers now exclusive technical support at ATHENS METROPOLITAN EXPO the largest, newest exhibition & conference center in Athens.

EXPOWORK offers technical support to exhibitions, conferences & events.

It covers a wide variety of your exhibitional needs and guarantees the smooth running of every event, during construction, operation and dismantling.

- Commitment to the exhibition and convention needs
- Technical Expertise
- Highly specialized personnel in a wide range of activities
- Integrated portfolio of exhibition services
- Use of modern technical infrastructure and designing programs
- Excellent knowledge of the Exhibition Center due to exclusive activity in ATHENS METROPOLITAN EXPO

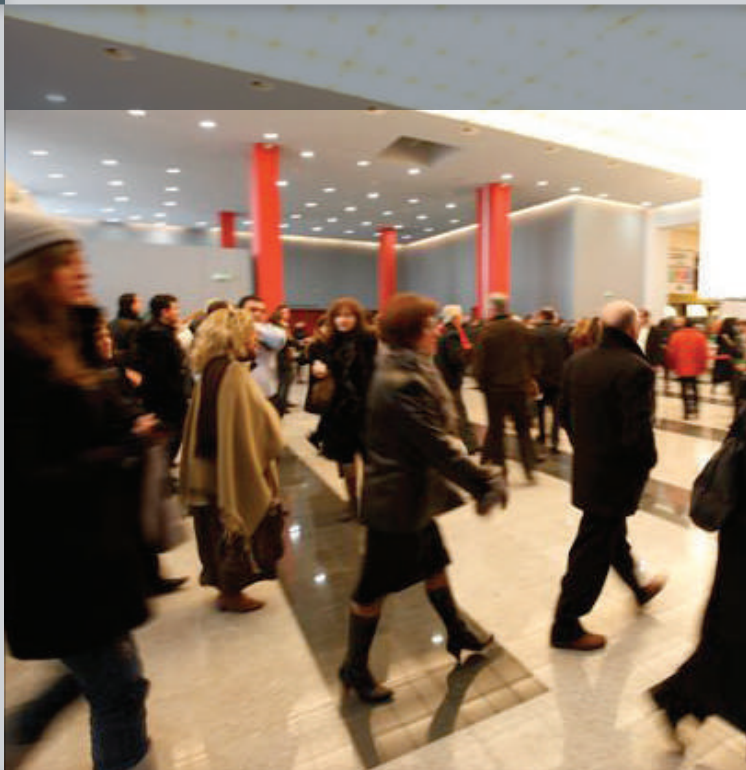



## Services

The company's core activity is rendering exhibition and congress services.

The range of services covers:

- Standard and upgraded types of shell scheme stands
- Construction of customized stands
- Electrical services
- Furniture hire
- Security services
- Audiovisual media
- Lift services
- Photo shooting & video coverage
- Connections to water supply & drained network
- Wireless internet connections
- Cleaning services
- Rigging services
- Digital printings
- Ventilation service

EXPOWORK's customer oriented philosophy and its focus on the exhibitors needs, enhanced by its Know-how and expertise, makes our company a valuable partner for you during your participation at the exhibitions and the events.



# Metropolitan Expo

Metropolitan Expo is the largest, most modern and functional venue for exhibitions, conferences and events in Greece and one of the finest areas in Southern Europe



Metropolitan Expo covers a total of 50,000 m<sup>2</sup> indoor space that includes:

- Four (4) large, modern exhibition halls from 6,000 to 13,000 m<sup>2</sup> in parallel provision on the same level
- Two (2) conference halls, with 600 and 300 people capacity respectively. They have full audiovisual equipment, lighting dimmer, air conditioning and internet connection
- Two (2) impressive, independent reception halls (Lobbies 1 & 2), with a variety of services, sized 3,000 m<sup>2</sup>, both of austere luxury, exceptional functionality and aesthetics
- One (1) comfortable main corridor of high aesthetics, with natural light and visibility, which consolidates all Centre's spaces, offering to visitors advanced services and infrastructures (rest areas, info kiosks, displays with routes for metro-suburban etc)
- Three (3) outdoor events' spaces of a total area of 6,800 m<sup>2</sup>, which can accommodate any type of event, in a unique environment
- Seven (7) café and two (2) restaurants, stylish & functional
- Two (2) parking areas (PA & PB) of a total area of 100,000 m<sup>2</sup>, designed for easy access and movement of vehicles
- 8,000 m<sup>2</sup> outdoor green areas, environmentally managed and in alignment with the wider natural environment





Metropolitan Expo is proved to be an ideal exhibition structure, hosting large scale events.

Our main competitive advantages are:

- Very tall exhibition halls, from 7 to 12 meters
- Development at a single level for easy access and events' management
- Many, spacious and fully accessible entrances for cargos & goods
- Floor structure for electrical, plumbing and sewer services
- Full air conditioning and ventilation of indoor space
- Advanced fire detection and fire protection systems
- State of the art technological infrastructure (telephony, wireless internet, sound installation)
- Easy circulation of visitors in all areas of the Centre.

Access to Metropolitan Expo is more than easy, with many travel options.

In detail:

- Metro, Suburban Railway, Urban (OASA) and Intercity (KTEL) Buses
- By air, connected with many domestic, European and worldwide destinations
- By car, via the Attiki Odos and regional roads (Vari - Koropi, Lavrion etc).

Metropolitan Expo is connected via shuttle bus, in a very short time and continuously with all the stops of public transport of the airport. More generally, the Exhibition and Convention Centre, is quickly and easily accessed from Athens, rest of Greece and abroad. A significant competitive advantage of Metropolitan Expo is the enormous, functional parking lots on a total area of 100,000 m<sup>2</sup>, with a capacity of over 4,500 cars.

## Standard shell scheme stand



The 2.50 m-height standard stand, is made of a natural coloured aluminum frame , with white-coloured PVC panels (OCTANORM).

Above the stand entrance and at 2.20m height, these stands have a perforated aluminum fascia accommodating the stand number and exhibitor's name in digital printing on white PVC. The floor is covered with carpet (colour selected by the organizer). The ceiling hosts aluminum beams, one by 2.00m across the length of the stand.

Furniture and electrical equipment is provided according to organizer's standards.

### STAND 2.50 m-HEIGHT

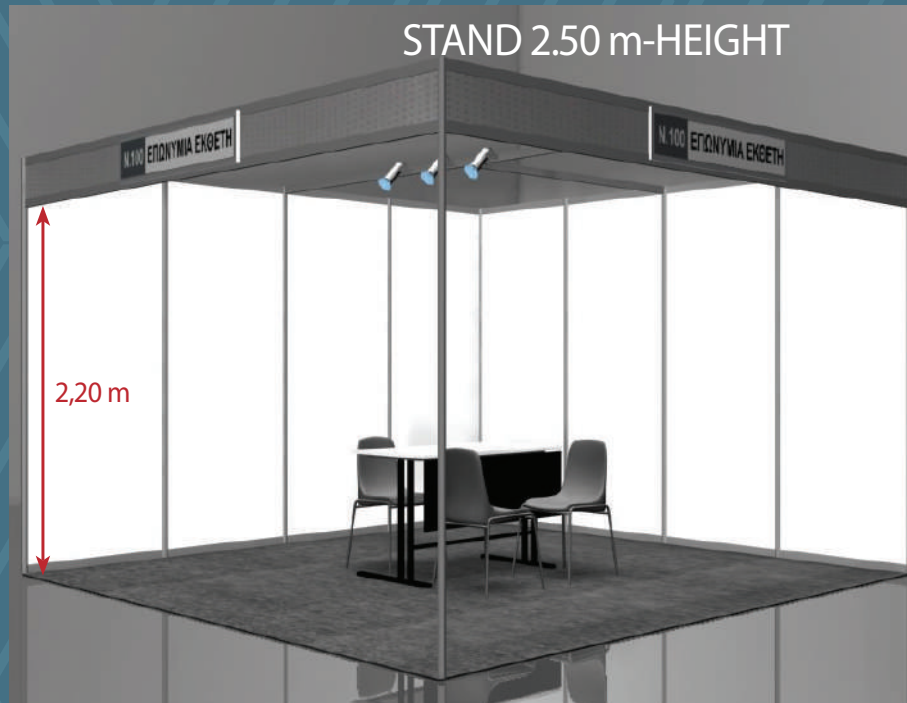

### STAND 3.00 m-HEIGHT

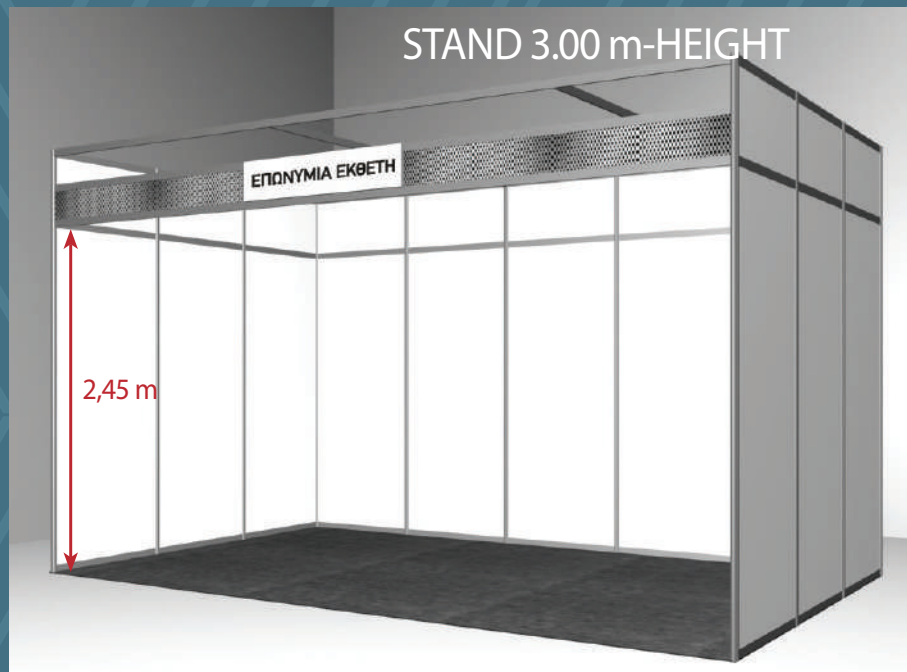

## Dimensions standard shell scheme stand

Please note no fixings may be made directly all the walls. A comprehensive range of fixing components are available. Please contact the Shell Scheme Contractor for advice. All materials must be removed at the end of the exhibition without causing any damage to the wall panels which burdens the customer.

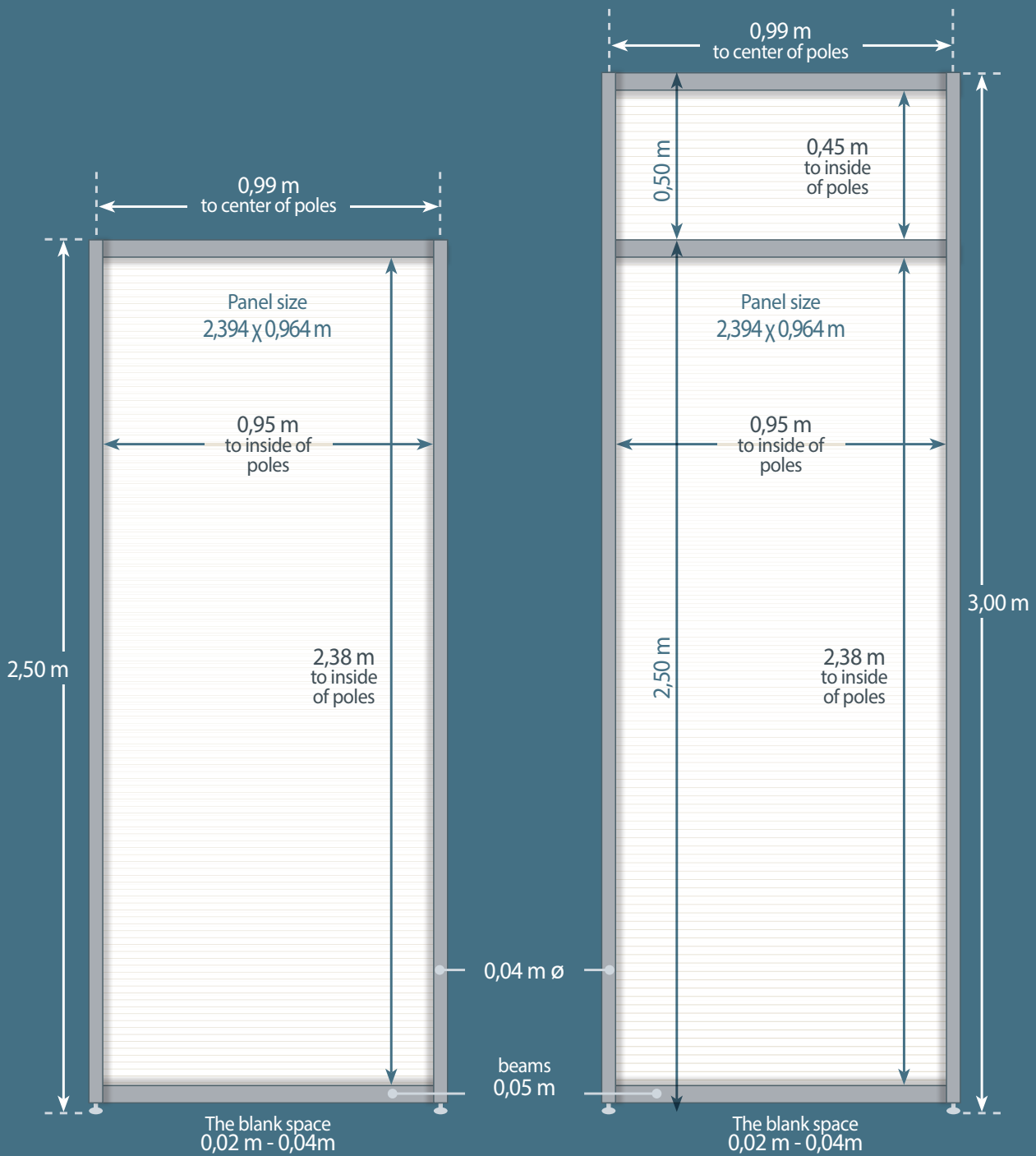
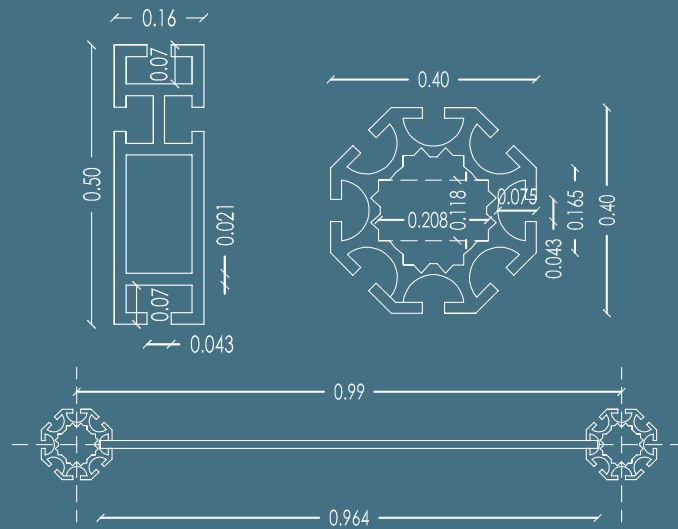

Electrical equipment & Services



04010100

▶ Spotlight led 12Watt



04010200

▶ 3x12Watt led spotlight bar



04012501

▶ LED 100 Watt floodlight



04012502

▶ LED 180 Watt floodlight



04013100

▶ Grounded socket up to 0.5KW/220V

04013600

▶ Grounded socket up to 0.5KW/220V 24h (on ground)

04015300

▶ Ceiling socket up to 0.5KW/220V



04014400

▶ Column with adjustable height up to 4m holding up to 8 floodlights (depending on size and weight of the attached floodlights)

Electrical Services Drawing form 47 page SERVICE Catalogue 2027



KWatt power supply is 380-400Volt/3phases (please inform us if there is any other need)



Single KW power-supply is provided up to 70kw (with up to 5x35mm<sup>2</sup> cable)



04013200

▶ KW power supply

04013400

▶ Installation of floodlights

04013500

▶ Placement of floodlights

04014100

▶ Electrical switch board with 3 switches

04013700

▶ Electrical switch board with 6 switches

04013800

▶ Electrical switch board with 12 switches

Note

Electrical installations performed by exhibitors or subcontractors, must be accompanied by a sworn statement (template available from Expowork) and a copy of the electrician's license.

04015000

▶ Electrical installations for special design stands (wooden or aluminum construction e.t.c.) may be performed following special arrangements, provided that the exhibitor has so requested,atleast 15dayspriorto the opening of the exhibition.

Cost estimate upon request.

Special design stands must necessarily have electrical switch board with safety relay 3phase installation.

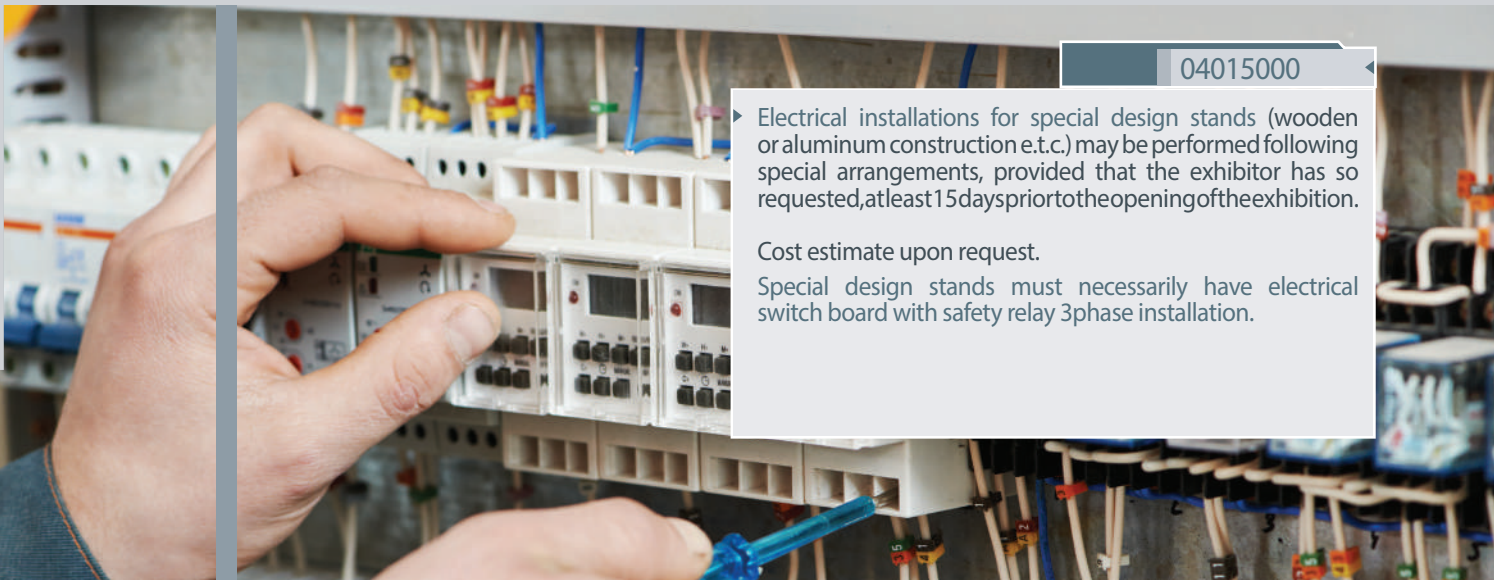



Stand equipment

Partitions\ Panels\ Doors  
(for constructing storages, meeting rooms etc)



03010103

▶ P13 PVC panel 1.00x2.50



03010202

▶ P23 Sand blasted Plexiglass panel 1.00x2.50



03010305

▶ P33 Aluminum door 1.00x2.50



03010404

▶ P43 Folding door 1.00x2.50



03012100

▶ P46 Wooden white door

Drawing Equipment Form page 47 SERVICE Catalogue 2027

Dimensions are: W x H



3

Ceilings



03075100

▶ R1 Aluminum grid 1.00x1.00m

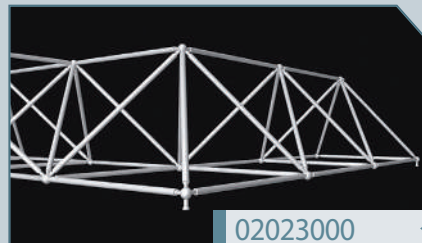

02023000

▶ Aluminum tube construction of 1.00x1.00m



03076000

▶ R2 Ceiling aluminum beam to hold extra spotlight





Stand equipment

Chairs

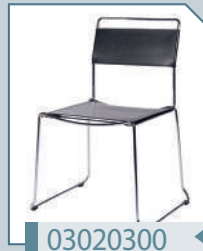

03020300

▶ K3 Black leather chair



03020400

▶ K4 Grey plastic chair



03020401

▶ K4.2 Beige plastic chair



03020500

▶ K5 Blue Chair

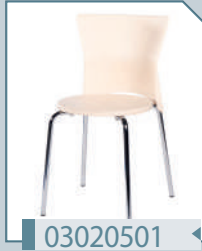

03020501

▶ K5.2 Beige Chair



03020502

▶ K5.3 Red Chair



03021300

▶ K13 Beech wood chair

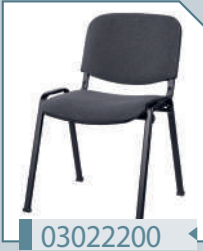

03022200

▶ K22 Chair



03022300

▶ K23 Blue visitor armchair

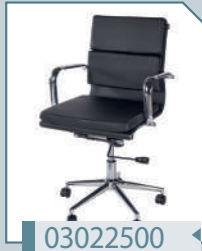

03022500

▶ K25 Black swivel chair

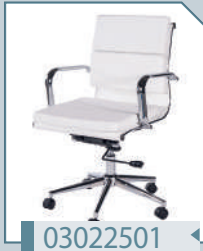

03022501

▶ K25.1 White swivel chair

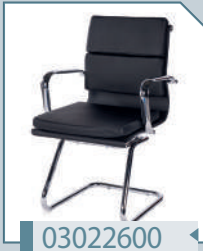

03022600

▶ K26 Black visitor armchair



03022601

▶ K26.1 White visitor armchair

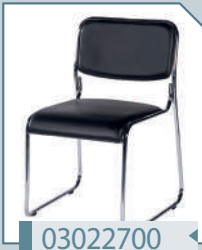

03022700

▶ K27 Blackcampus chair

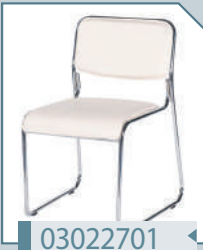

03022701

▶ K27.1 Off white campus chair



03022800

▶ K28 Black Libra chair



03022801

▶ K28.1 White libra chair



03022802

▶ K28.2 Beige libra chair



03022900

▶ K29 Colourful art chair



03023000

▶ K30 Plexiglass art chair



03023100

▶ K31 Black chair with wooden legs



03023101

▶ K31.1 White chair with wooden legs





Stand equipment

Chairs

					
03023300	03023301	03023200	03023201	03024601	03024600
▶ K33 Black linea chair	▶ K33.1 White linea chair	▶ K32 Black art chair	▶ K32.1 White art chair	▶ K46.2 Charcoal Moda Chair	▶ K46.1 White Moda Chair

					
03023500	03023501	03024801	03024800	03024900	03025100
▶ K35 Black wooden Optim armchair	▶ K35.1 White wooden Optim armchair	▶ K48 Black Lina Chair	▶ K48.1 White Lina Chair	▶ K49 White Blend Chair	▶ K51 Black visitor denim chair

Armchairs

			
03023900	03023901	03024200	03024201
▶ K39 Black Barcelona lounge chair 0,75x0,80x0,80m (h)	▶ K39.1 White Barcelona lounge chair 0,75x0,80x0,80m (h)	▶ K42 Black Genova lounge chair 0,80x0,75x0,75m (h)	▶ K4 White Genova lounge chair 0,80x0,75x0,75m (h)

	
03024300	03023400
▶ K43 Greige armchair Evelyn	▶ K34 Black Sara chair



Stand equipment

Stools

				
03020900	03021000	03024701	03024700	03021400
▶ K9 Bar stool black	▶ K10 Black bar stool with back	▶ K47.2 Black bar stool Moda	▶ K47.1 White bar stool Moda	▶ K14 Bar stool oak
				
03021800	03021801	03021802	03023600	03023601
▶ K18 White bar stool	▶ K18.1 Red bar stool	▶ K18.2 Black bar stool	▶ K36 Black bar stool Alfi	▶ K36.1 White bar stool Alfi
				
03023700	03023701	03024100	03024101	
▶ K37 Black bar stool Art	▶ K37.1 White bar stool Art	▶ K41 Black bar stool Moss	▶ K41.1 White bar stool Moss	

Sofas

		
03021100	03021100	03021105
▶ K11 Two-seat sofa black 1,50x0,75x0,75m (h)	▶ K11.2 Two-seat sofa white 1,50x0,75x0,75m (h)	▶ K11.4 Two-seat sofa black Genova 1,25x0,75x0,75m (h)
		
03023800	03023801	03021106
▶ K38 Three-seat sofa black Barcelona 1,85x0,80x0,80m (h)	▶ K38.1 Three-seat sofa white Barcelona 1,85x0,80x0,80m (h)	▶ K11.5 Two-seat sofa white Genova 1,25x0,75x0,75m (h)





Dimensions are: L x W x H or ø x H

Stand equipment

Tables

 <b>03040102</b>	 <b>03040202</b>	 <b>03040400</b>
▶ T3.3 White table 1.20x0.60x0.72	▶ T4.3 White folding table 1.80x0.76x0.76	▶ T6 Glass conference table 1.60x0.80x0.75

 <b>03040500</b>	 <b>03040510</b>	 <b>03040520</b>	 <b>03040800</b>
▶ T7 Round glass table ø 1.00	▶ T7.1 Round glass table ø 0.90x0.77	▶ T7.2 Round glass table ø 0.80x0.77	▶ T10 Round beech wood table ø 0.70x0.73

 <b>03040801</b>	 <b>03040802</b>	 <b>03040900</b>	 <b>03042700</b>	 <b>03042800</b>
▶ T10.1 Round table black ø 0.70	▶ T10.2 Round table white ø 0.70	▶ T11 Round sand blasted glass table ø 0.70x0.75	▶ T20 Table for laptop solid 0.48 x 0.32 x 0.58	▶ T21 Table with glass surface volter 1.40x0.80x0.75

 <b>03043100</b>	 <b>03043101</b>	 <b>03043200</b>	 <b>03043201</b>	 <b>03042900</b>
▶ T24 Round table art white ø 0.80x0.74	▶ T24.1 Round table art black ø 0.80x0.74	▶ T25 Table art white surface 1.60x0.90x0.74	▶ T25.1 Table art black surface 1.60x0.90x0.74	▶ T22 Glass round table posto ø 1.20x0.73

 <b>03041000</b>	 <b>03042000</b>	 <b>03043000</b>	 <b>03043001</b>	 <b>03044100</b>
▶ T12 Square glass table (tall) 0.60x1.10	▶ T13 Round glass table (tall) ø 0.60x1.10	▶ T23 White tall table lavida 1.20x0.60x1.06	▶ T23.1 Black tall table lavida 1.20x0.60x1.06	▶ T32 Round table tall white ø 0.70 x 1,10

 <b>03044101</b>	 <b>03043800</b>	 <b>03043900</b>	 <b>03040602</b>	 <b>03040603</b>
▶ T32.1 Round table tall black ø 0.70 x 1,10	▶ T30 White table art 0.80 x 0.80 x 0.73	▶ T30.1 Black table art 0.80 x 0.80 x 0.73	▶ T8.3 Low square table white 0.47x0.47x0.40	▶ T8.4 Low square table beech wood 0.47x0.47x0.40

 <b>03040701</b>	 <b>03043300</b>	 <b>03043400</b>
▶ T9.1 Low glass square lounge table 0.50x0.50x0.45	▶ T26 Low glass table black-inox 1.10x0.55x0.45	▶ T27 Low glass table black-inox 0,55x0,55x0,45



Stand equipment

Desks & Drawers

Dimensions are: W x H



03030102

▶ T1.3 White desk  
1.20 x 0.60 x 0.72



03043600

▶ T28 Executive desk with oak surface  
1.40 x 0.80 x 0.76m



03043700

▶ T29 Executive desk with grey surface  
1.40 x 0.80 x 0.76m



03030601

▶ White drawer

Showcases

Showcases do not include lighting and locks.

Shelves are placed by the exhibitor



03050102

▶ V1.3 White showcase  
1.03x0.54x2.20



03050202

▶ V2.3 White showcase  
0.54x0.54x2.20



03050302

▶ V3.3 White showcase  
1.03x0.54x1.05



03050403

▶ V4.3 White jewels showcase  
1.03x0.54x2.20



03050500

▶ V5 Crystal shelf  
1.05x0.30



03050602

▶ V6.3 Melamine shelf white  
1.10x0.30



03050702

▶ V7.3 Shelf case white  
1.03x0.28x2.20



03051300

▶ V9 Glass rolling display case  
1,65\*0,35\*0,60 with white top & a lock



03050802

▶ C1.3 Cube white  
0.54x0.54x0.60



03050902

▶ C2.3 Cube white  
0.54x0.54x0.80



3

Stand equipment



Stand equipment

Special equipment



03060103

▶ SE1.3 Curved info desk white 1.03x0.71x1.07



03060220

▶ SE2.7 Curved Info desk white 1.44x0.54x1.07



03060205

▶ SE2.6 Curved Info desk white 1.40x0.60x1.00



03060302

▶ SE3.3 Corner bar white 1.53x1.03x1.07



03060400

▶ SE4 Refrigerator white 0.54x0.57x0.86



03062500

▶ SE7 Refrigerator grey/silver 0.54x0.57x0.86



03060900

▶ SE5 Sink with cupboard and faucet 0.90x0.60x0.80



03060501

▶ OE1.2 Beech wood cabinet with 2 doors & lock 0.80 x 0.45 x 0.71



03063500

▶ OE12 Cabinet of aluminum structure 1.00x0.50x1.02



03060700

▶ OE3 Standing coat hanger



03060702

▶ OE6 Inox wheeled coat hanger (1,38m length)



03060801

▶ OE4.2 Frame adjusted coat hanger (0,95 m length)



03060601

▶ OE2.2 Beech wood cabinet with 2 doors & lock 0.90 x 0.45 x 1.20



03061600

▶ OE9 White wood cabinet 0.80x0.45x0.83



03060603

▶ OE2.3 White wood cabinet 0.60x0.32x1.15



03062100

▶ OE10 Full length mirror



03061300

▶ OE8 Floor stand brochure holder (3 x A4)



Stand equipment

F1 Carpet with nylon

Floors – Floor Coatings



F2 Platform



Platform up to 12cm without layer



3

Stand equipment

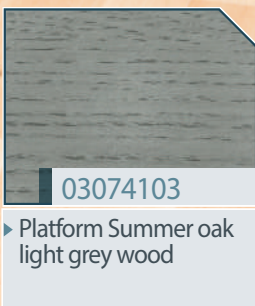
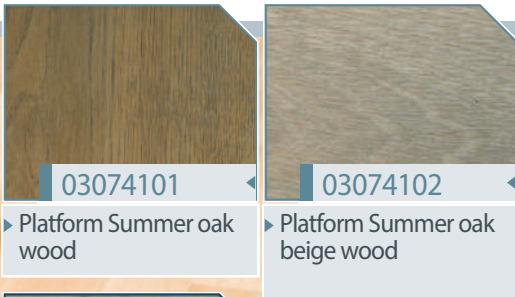



# Signage – Printing services

There are various categories of printing services available.

(creative design is not included)

Prices depend on sizes and placement method.

Printing themes should be in a linear design (file type illustrator) or in natural size at 100dpi for printing until 2 m<sup>2</sup> and in 1/100 at 300 dpi for printings over 2 m<sup>2</sup>.

## Signage – Printing services

DESCRIPTION	INDICATIVE PRICES	
1 Digital printing on vinyl (self-adhesive or not)	up to 5m <sup>2</sup>	€ 28,56 m <sup>2</sup>
2 Digital printing on canvas	6 to 10m <sup>2</sup>	€ 28,56 m <sup>2</sup>
3 Digital printing on mesh	11 to 15m <sup>2</sup>	€ 28,56 m <sup>2</sup>



1 Digital printing on vinyl (3.00m)



1 Digital printing on vinyl (2,50m)

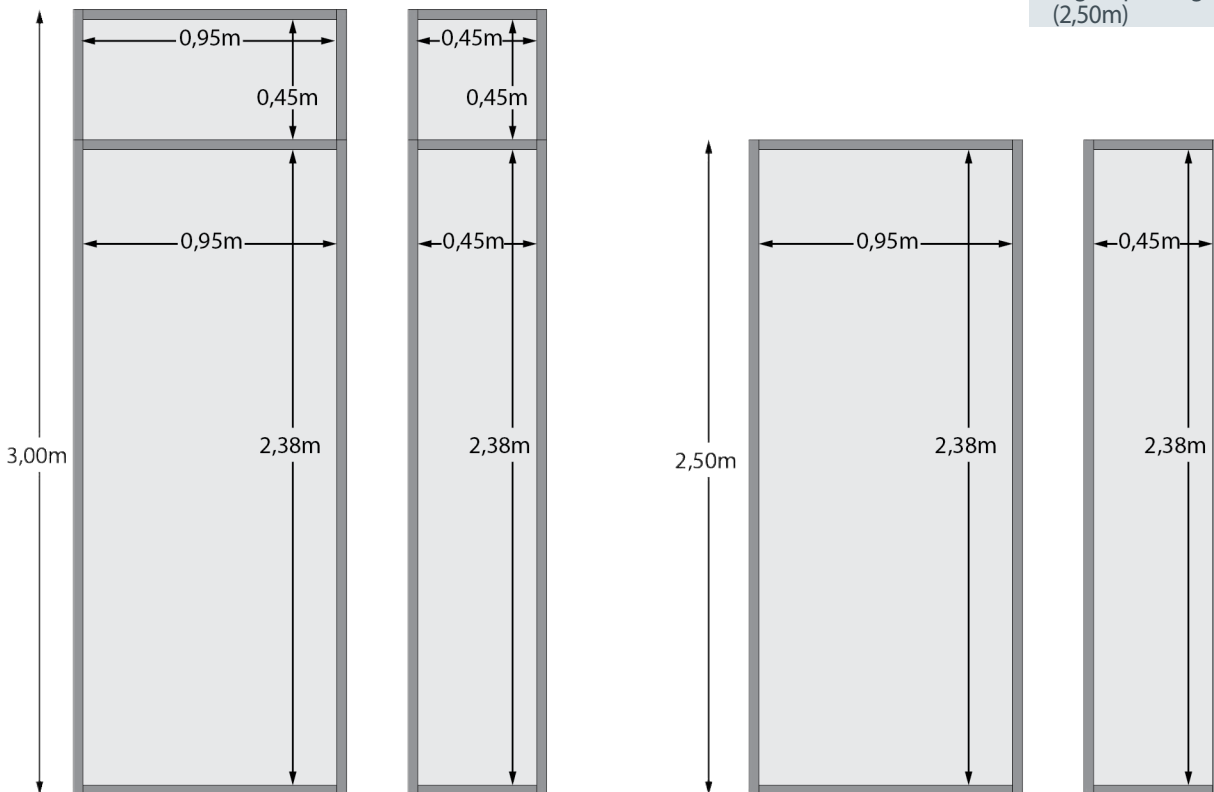



# Signage – Printing services

There are various categories of printing services available.

Prices depend on sizes and placement method.

Printing themes should be in a linear design (file type illustrator) or in natural size at 100dpi for printing until 2 m<sup>2</sup> and in 1/100 at 300 dpi for printings over 2 m<sup>2</sup>.

## Signage – Printing services

	DESCRIPTION			INDICATIVE PRICES
4	Digital printing on K-Mount 3mm	max ply dim:	1,22 x 2,44	€ 59,02 m <sup>2</sup>
5	Digital printing on K-Mount 5mm	max ply dim	1,50 x 3,05	€ 76,16 m <sup>2</sup>
6	Digital printing on K-Mount 10mm	max ply dim	1,50 x 3,05	€ 93,30 m <sup>2</sup>



4

Signage - Printing services



4

K-MOUNT 3mm



7

Canvas on frame

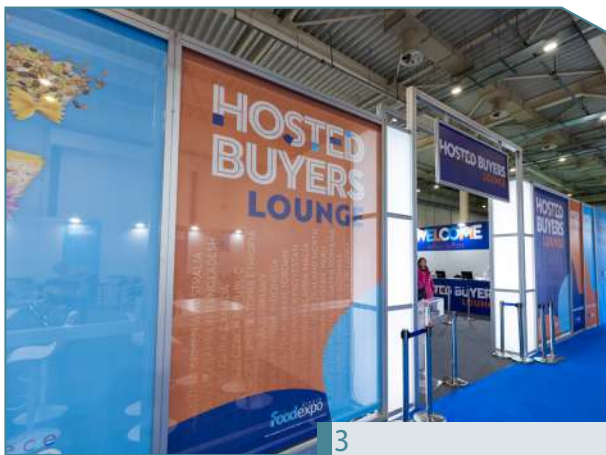

3

mesh



8

Roll Up Stand Display 0.80x2.00m



Aluminum framed printings for rigging



a. Lighted cube with printings & white fabric at bottom



b. Lighted rectangular with printings & internal white lining



c. Rectangular with printings & internal white lining



d. Lighted long sign with printing (single or double sided)

Light box with led



a. Led light boxes



b. Led light cube



c. Led light stand



d. Led light infodesk





Audiovisual  
- Office  
equipment



▶ TV Plasma

40"-42" HD 05010602

48"-50" HD 05010700

60" 05010601

75" HD 05010603

The devices that you will rent maybe different.

Photos of the devices are indicative.

Audiovisual  
equipment



05016202

▶ Led Poster (0,60\*2,02m)



05011802

▶ Projector 3000 Ansi lumen

4800 Ansi lumen 05011804



05016201

▶ Ledwall

Office  
equipment

Prices upon request



05012900

▶ Laptop



05013200

▶ Laser printers monochrome



05013201

▶ Laser printers coloured





Cleaning Services

6.1 Type 1

▶ Cleaning services for stands, during the night of 01/06/2027 before exhibition opening (cleaning of floor and furniture, exhibits not included)

up to 50m <sup>2</sup>	04020500
51m <sup>2</sup> to 100m <sup>2</sup>	04020600
101m <sup>2</sup> to 150m <sup>2</sup>	04020700
151m <sup>2</sup> to 200m <sup>2</sup>	04020800
Over 200m <sup>2</sup>	04020900

6.2 Type 2

▶ Cleaning services for stands, daily before the opening of the exhibition 01-04/06/2027 (cleaning of floor and furniture, exhibits not included)

up to 50m <sup>2</sup>	04021000
51m <sup>2</sup> to 100m <sup>2</sup>	04021100
101m <sup>2</sup> to 150m <sup>2</sup>	04021200
151m <sup>2</sup> to 200m <sup>2</sup>	04021300
Over 200m <sup>2</sup>	04021400

6.3 Type 3

▶ Special cleaning arrangements upon agreement (e.g. cleaning of products / exhibits)

	04021500
--	----------



6



Service Security

7 Security Service

- ▶ Security personnel guarding the stands according to exhibitors needs (preparation, exhibition hours etc)

04030500



Services Photo Video

8.1 Photography Service

- ▶ Simple photo shooting of the stand without an appointment and material delivery via link

10 photo 05061105



- ▶ Special photo shooting of your stand or exhibits with appointment and material delivery in high resolution file via link for usage on web pages, magazines, digital prints

20 photo 05062400

8.2 Video Service

- ▶ Video production, image processing, insertion of logos, editing. Presentation time up to 2 min. File send via link

05062600

- ▶ Video without montage for the stand.

05062700

- ▶ Video without montage for an event lasting maximum 2 hours.

05063200

05063302

05062701





## Internet

## 9.1 Wireless Internet

- ▶ Wireless INTERNET of unlimited access, maximum capacity 2Mbps, during the exhibition, through local wireless system. (Wireless LAN 802.11x).

05080150

## 9.2 Cable INTERNET

- ▶ Installation of a UTP CAT5e cable from an internet service area of the exhibition center, to a point inside the booth indicated by the exhibitor.
- Automatic IP address assignment for devices that will be connected, through DHCP.
- Continuous and uninterrupted internet service with guaranteed upload / download speed.
- Access to all Internet services (VPN, voip calls, video etc).
- Phone and onsite support in case of a problem with the IP address assignment and connection problems.

05080158

## 9.3 Optional services with extra cost:

- ▶ Possibility to use real internet static IP.
- Possibility to use network switch and extra cabling to interconnect multiple devices.
- Possibility to use WiFi Access Point to enable wireless interconnection of wireless devices.

05080153



9

Internet

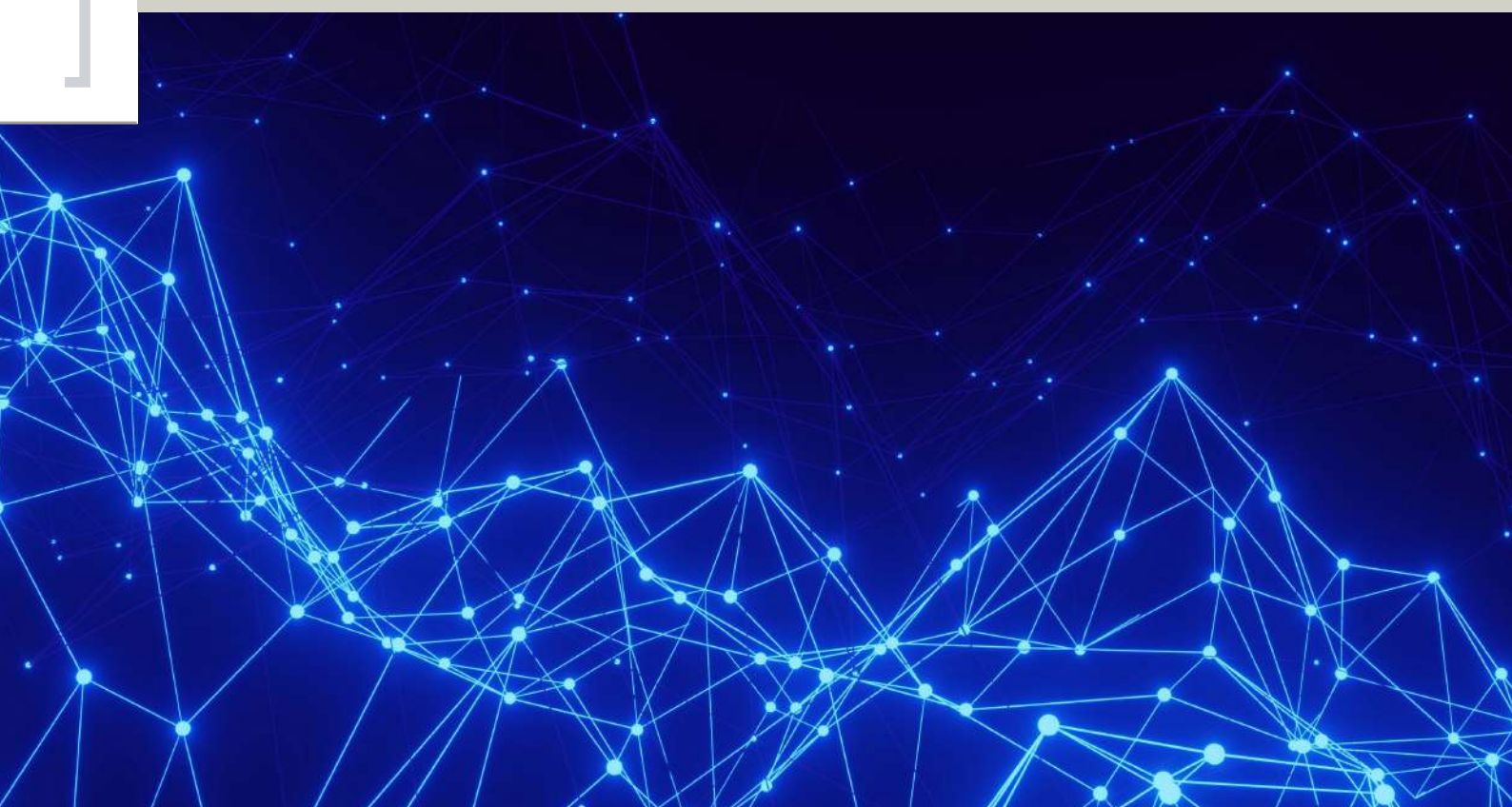



## Water supply-waste pipe connections

▶ Water supply and drainage network, including conjunction materials connected at the buildings termination points, as well as the required work time.

05080201

▶ Water supply at the exhibitor's stand, including connection materials at the building termination points, as well as the required work time.

05080202

▶ Appliance connection (coffee machines, dish washers, ice cube machines e.t.c.), provided that the appliance connection points should match the following specifications:

- Water supply:  $\frac{1}{2}$ " ,  $\frac{3}{4}$ " ,  $\frac{3}{8}$ "
- Waste water pipe:  $1 \frac{1}{4}$ "

05080205

▶ Rental and placement of grease collector 7lt

05080207



# 10

Water supply- waste pipe connections

## Connection to the ventilation network

▶ Includes the required work time and the necessary pipes / material, for your equipment (air extractor hoods, grills, vehicles) to be connected to the ventilation system. Pipe diameter: 30cm. In case your equipment does not match the above-mentioned specifications, you should be equipped with the relevant connection adapter.

Exhibitors who haven't requested this service or are not equipped with the appropriate connection adapter, WILL NOT be allowed to grill or use ANY machinery producing exhaust fumes or other emitting particles, according to the Metropolitan regulations.

05080300



### Remarks:

- The total surface of the hearth or grilling area should not exceed 1.5m<sup>2</sup>
- The chimney or extractor hood that will be used, should overlap the hearth or grilling area at least 15cm from each open side
- The chimney or extractor hood should have a shape that will be able to collect the vapor or the fume at the connecting point with the air pipe (ex. Conical)
- The chimney or extractor hood should be placed over the hearth or grilling area at a maximum height of 0,80m.
- At the connection point with the exhaust pipe, the maximum temperature should not exceed the 120oC.

# 11



## Rigging services - Freight rigging

### 12.1 Rigging point – Safety link up to 150kgr.

Freight rigging up to 150kgr from the building ceiling.  
It includes: The service of placing rigging points at the ceiling of the building (and their dismantling after the end of the exhibition) for the whole duration of the exhibition.

The equipment consists of: steel wire 8mm 2 meters for the connection to the metal frame of the building, shackle, steel wire 5mm 4.5 meters for the freight lifting, link 50 SV II of the REUTLINGER company. All the above totally fulfil the safety regulations of the German certification house TUV and have a safety degree 7 to 1.

04040100



### 12.2 Rigging point – Safety link up to 350kgr

Freight rigging up to 350kgr from the building ceiling.  
It includes: The service of placing rigging points at the ceiling of the building (and their dismantling after the end of the exhibition) for the whole duration of the exhibition.

The equipment consists of: steel wire 8mm 2 meters for the connection to the metal frame of the building, shackle, steel wire 5mm 4.5 meters for the freight lifting, link 80 SV II of the REUTLINGER house. All the above totally fulfil the safety regulations of the German certification house TUV and have a safety degree 7 to 1.

04040200

- In hall 4 only points of rigging with a safety link to 350 kg can be provided. (κωδ. 04040200)





Extra rigging equipment

12.3 Square Truss

Truss 20cm square 05130100

Truss 30cm square 05130200

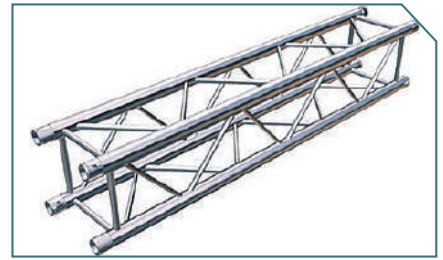

12.4 Square conjunction for truss

Square conjunction for truss 20 cm 05132100

Square conjunction for truss 30 cm 05132200

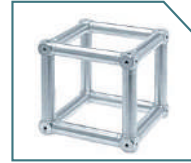

12.5 Rigging motor 250 kgr

05135100



12.6 Rigging motor 500 kgr

05135200











## EXHIBITOR'S INFORMATION

### A. STANDS UP TO 29sqm / SHELL SCHEME STANDS AND WOODEN TYPE

1. The standard shell scheme stand includes a basic electrical board which is placed on the top of one of the panel walls of the stand, according to electrician's discretion (except from business, executive and wooden stands where the board is placed in the storage room). If you wish this electrical board to be placed on a different panel, you will have to indicate it on a drawing/plan of your stand and send it to us the latest 30 days before the opening of the exhibition.
2. Orders that concern electrical equipment / installations or/and stand constructions, e.g. Installation or connection of floodlights, storage areas, ceiling beams to hold extra lights e.t.c., cannot be executed unless they are accompanied by a drawing/plan indicating their exact positions.
3. The permanent electrical supply of your stand (according to your order) becomes available 1 day before the opening of the exhibition only if your account with our company has been settled.
4. Drilling and painting of melamine and wooden panels and aluminum frames of booths offered by Expowork are not permitted.

### B. STANDS ABOVE 30sqm / OPEN SPACE STANDS

1. The order of the stand's power supply should be sent to us the latest 30 days before the opening of the exhibition, attaching a drawing/ plan indicating the position of your electrical board. In case we do not receive the accompanying drawing, your order cannot be executed.
2. The electrician performing the electrical installations in your stand has to fill in, sign and stamp the Electricians' Solemn Declaration Form, mentioning the total power supply in kw needed, as also to attach a copy of his professional license (expiration date and number must be distinct).
3. The Electricians' Solemn Declaration Form which is filled in by the exhibitor's electrician is an accompanying document to the electrical equipment form order which needs to be filled in, by the exhibitor.
4. Open space stands must have installed an electrical board with differential relay. If not, it is possible to order such kind of electrical board, through Expowork.
5. In order to test the electrical installations at your stand, during the exhibitions' build-up period, the "Electricians' Solemn Declaration Form" should have already been sent to Expowork's customer service department.
6. During the build-up period, electrical power sockets are provided in specific positions of each Hall for the stand's construction needs and they operate only during this period.
7. The permanent electrical supply of your stand (according to your order) becomes available 1 day before the opening of the exhibition, only if all documents ("Electricians' Solemn Declaration Form" and professional license) have been submitted and your account with our company has been settled.

### POWER CONSUMPTION

For all types of stands, it is necessary to order power consumption which concerns the consumption of all electrical products and services, like spotlights, floodlights, sockets, power supply e.t.c. and is charged accordingly.





## INSTRUCTIONS FOR THE EXHIBITOR'S INSTALLATION - DEPARTURE SETTLEMENT

- Upon arrival at the ATHENS METROPOLITAN EXPO, the exhibitor or his authorized representative shall take delivery of the stand from the hall supervisor.
- All sides of special design stands must be aesthetically acceptable, mainly at the border of different stands. The rear side of constructions exceeding 2,5m in height must also be presentable and painted white.
- Fire stations or fire extinguishers, electrical elements, water supplies or waste pipe connections must not be covered by any sort of structure for easy access in case of emergency.

The following actions are not permitted:

- Cutting wood or plasterboards, as well as using power-tools and equipment, such as spray paint compressors, anywhere inside the Exhibition Centre. Such operations are only permitted outdoors at special designated areas.
- Drilling and nailing on the floor, the pillars, the ceiling and any other structural part of the building.
- Drilling and painting of panels and aluminum frames (for suspending purposes, you may request special hooks from the exhibitors' service desk).
- Suspending any item from the ceiling or any other structural part of the halls, or the utility network lines, running parallel to the ceiling.
- Covering walls and corridors.
- Any intervention to the electrical installation without prior approval of the facility's chief electrician
- Should you object or disagree to any service provided by Expowork, please inform our Customer Care Dept. by the end of the exhibition opening day.
- Our equipment and services are only provided during the official duration of the exhibition. Our equipment is to be ready for recollection by our staff, 1 hour after the end of the exhibition.
- Electricians who undertake electrical installations of Customized Stands, are obliged to fill in the relative sworn statement (check with the EXPOWORK - Customer Service Dept.), attaching a photocopy of their professional license and hand it over to the EXPOWORK - Customer Service Dept., in order for their stand to be supplied with electricity.

- Breach of any of the above regulations leading to any damage, shall entail the full restoration of such damage and compensation deposit as calculated by EXPOWORK.
- Cleaning of paint brushes and other painting equipment is permitted only in the industrial sinks, situated in each exhibition Hall.

## DEPARTURE

After the end of the exhibition, exhibitors will first settle any outstanding financial affairs with EXPOWORK, and then depart, within the time limit specified by the organizer, after having removed all exhibits and decoration materials used during the exhibition. Should the exhibitor leave any construction material on site, a removal cost will be charged.

## REMARKS ON THE PRICE LIST

For your order to be valid, and forwarded for implementation so that it can be ready by the time you arrive at the METROPOLITAN, you must send the order form within the designated time frames (as described in the order forms), and fully pay the respective amount by bank transfer, or VISA, MASTERCARD, DINERS, or at the Expowork cashier's desk.

PIRAEUS Bank account no.:	GR840172202000-5202-018-199-548
NATIONAL BANK OF GREECE Bank account no:	GR97 01100750 0000 0754 7022 553
EUROBANK account no:	GR59 0140 1730 1730 0200 2003 777
ALPHA BANK Bank account no:	GR5802600980000950200587898

For exhibitions, events & conferences having 1-2 days duration, the 3 days charges will apply.





---

Address:  
**METROPOLITAN EXPO,**  
**International Airport of Athens, "El.Venizelos"**  
**190 19 Spata, Attika**  
**P.O. BOX 800 48**

Contact number:  
**+30 210 3542990**

e-mail:  
**defea@expowork.gr**

Website:  
**www.expowork.gr**

